

LTS-3APC24200-2

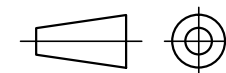

产品型号		LTS-3APC24200-2	
驱动方式		恒压型	
单位	mm (毫米)	调节级别	无级调节
比例	1:1	输入	AC100~240V 50~60Hz
版本	NO 1.0	总输出功率	200W
具备触发功能			

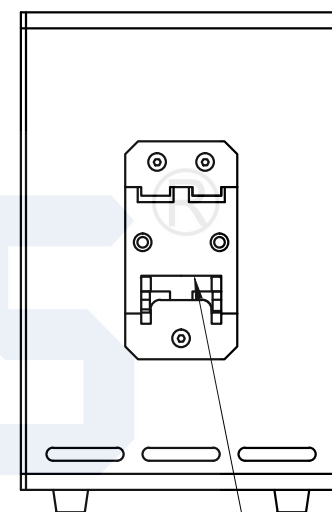
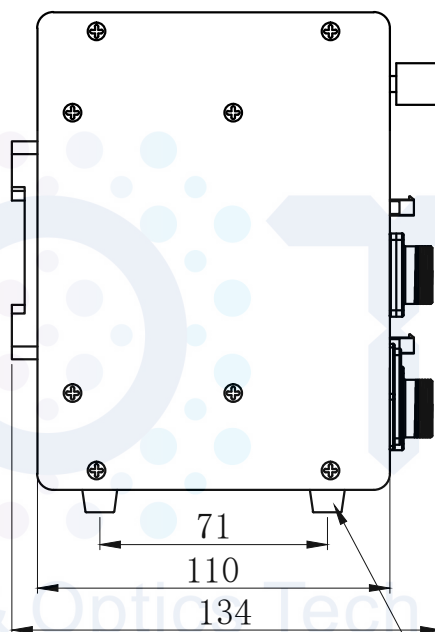
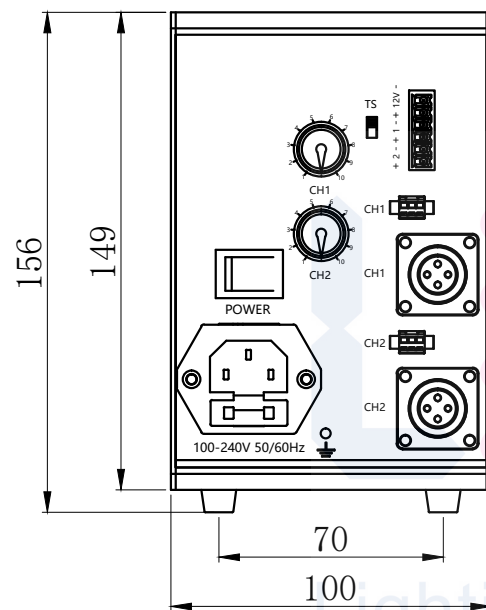

DIN导轨安装座

4-M3(4个支脚拆后可作安装孔)

